



AAP

ACOUSTIC PRODUCTION



RW 35-55
(SUBJECT TO MANUFACTURING SPECIFICATION)

PRODUCTION

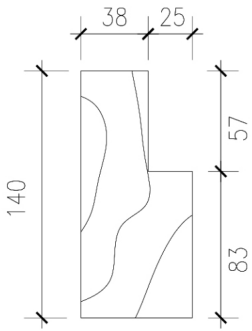

TIMBER DOOR FRAME

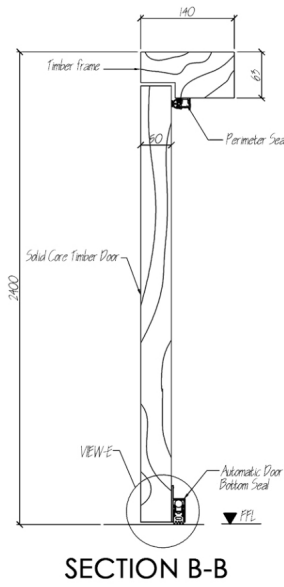

SECTION B-B

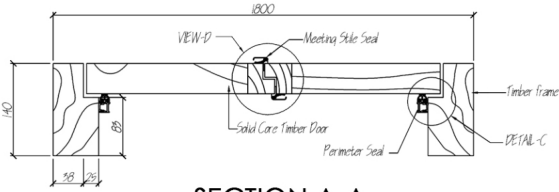

SECTION A-A

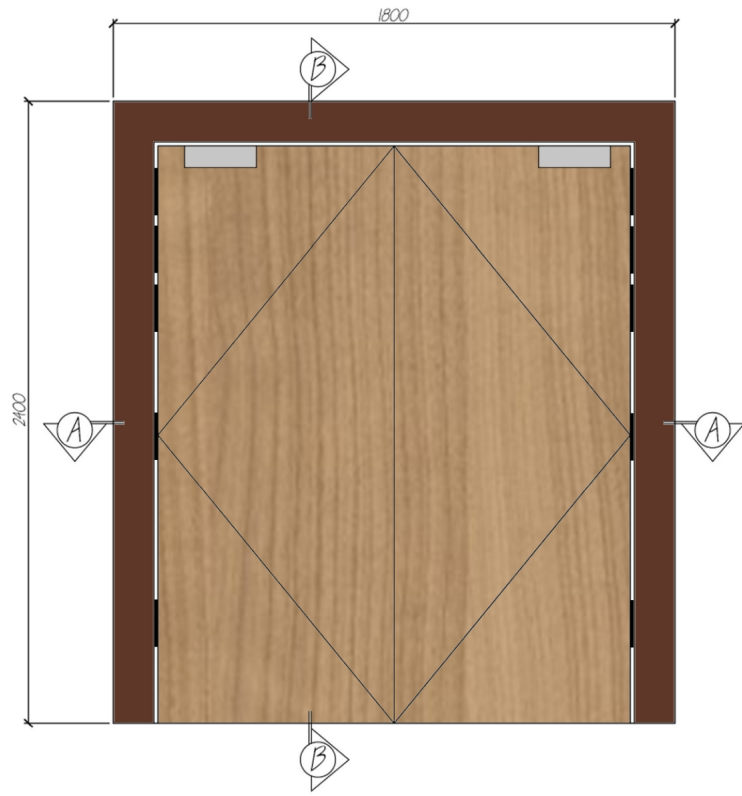

AWP DOUBLE LEAF TIMBER ACODOR

- WE PROVIDE:**
- ACOUSTIC TIMBER DOOR
 - 1 & 2 HOUR FIRE-RATED DOOR
 - ID TIMBER DOOR
 - TIMBER DOOR FRAME
 - DOOR HARDWARES

- APPLICATION:**
- RESIDENTIAL
 - COMMERCIAL
 - HOTEL
 - OFFICE

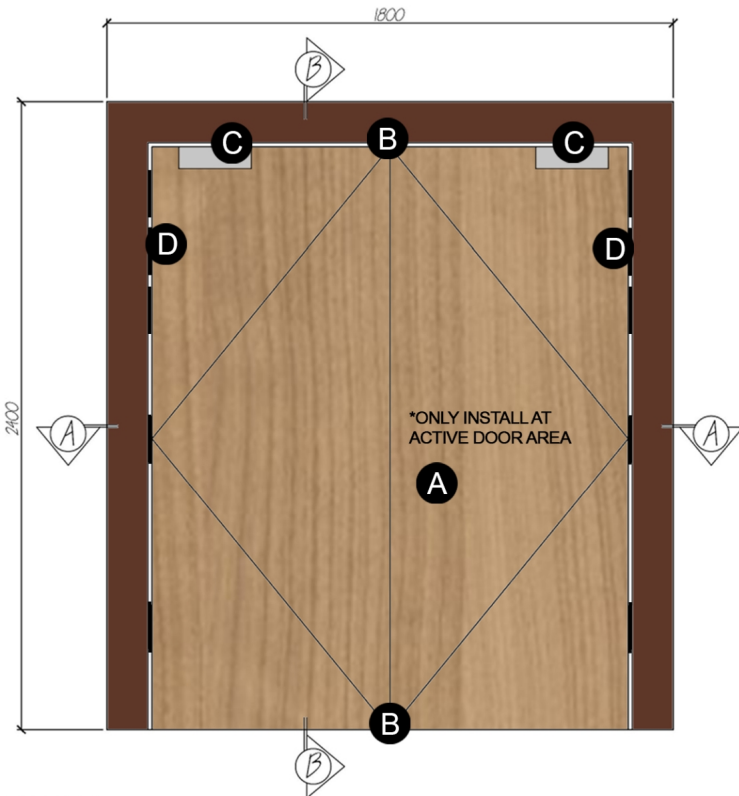

LEGEND

- A** HANDLE & MORTISE LOCK SET
- B** DOUBLE LEAF - AUTOMATIC BOLT
- C** DOOR CLOSER
- D** STAINLESS STEEL HINGERS

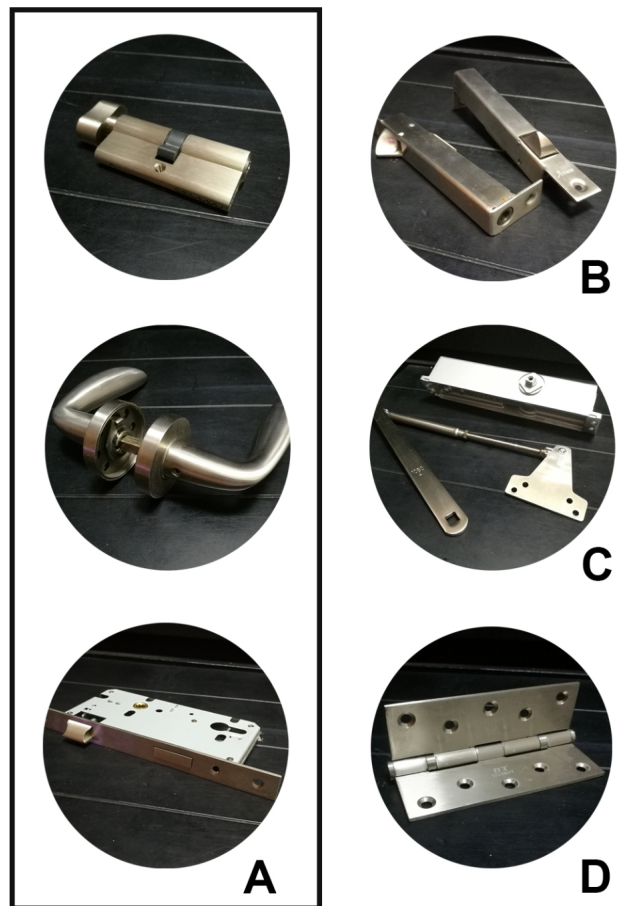

SAMPLE PHOTO

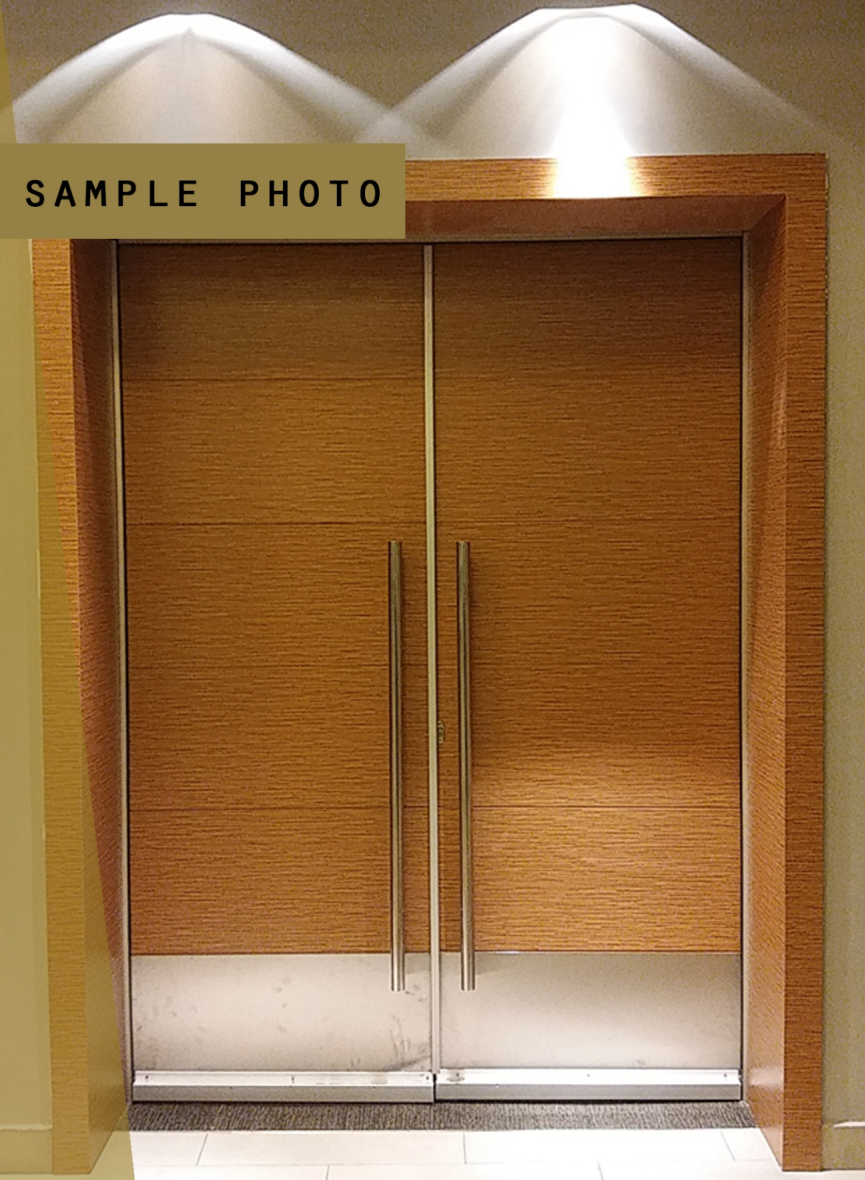

PRODUCTION

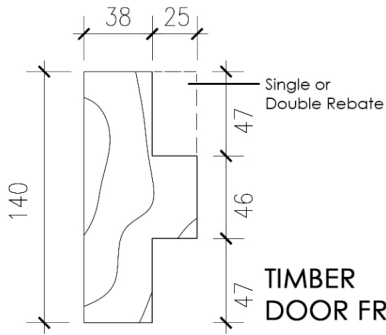

TIMBER DOOR FRAME

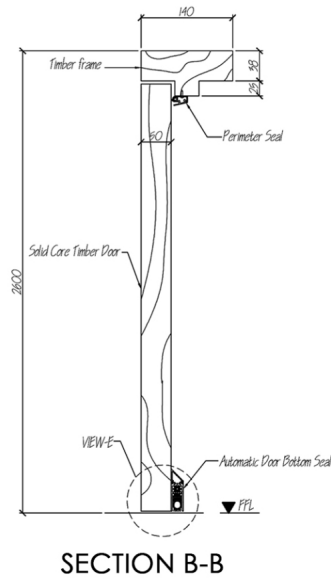

SECTION B-B

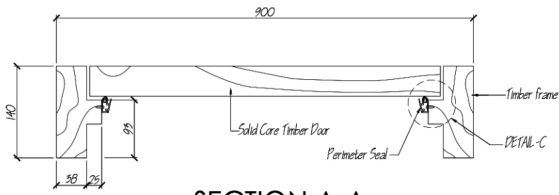

SECTION A-A

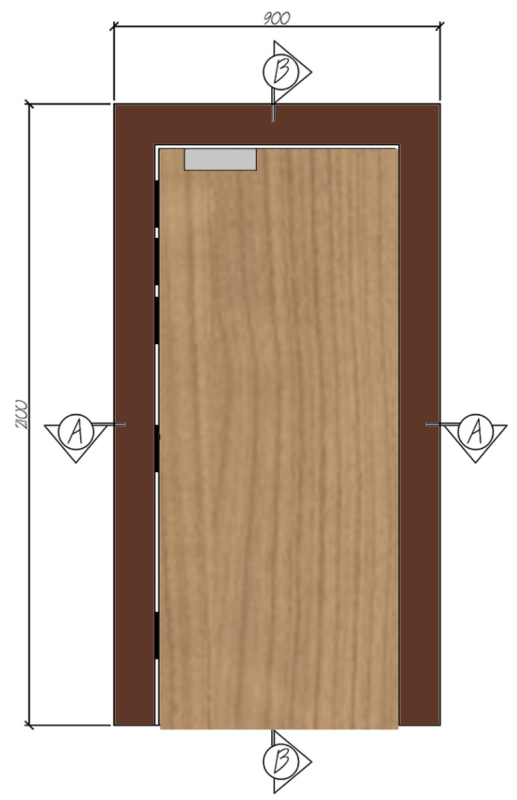

AWP SINGLE LEAF TIMBER ACODOR

- WE PROVIDE:**
- ACOUSTIC TIMBER DOOR
 - 1 & 2 HOUR FIRE-RATED DOOR
 - ID TIMBER DOOR
 - TIMBER DOOR FRAME
 - DOOR HARDWARES

- APPLICATION:**
- RESIDENTIAL
 - COMMERCIAL
 - HOTEL
 - OFFICE

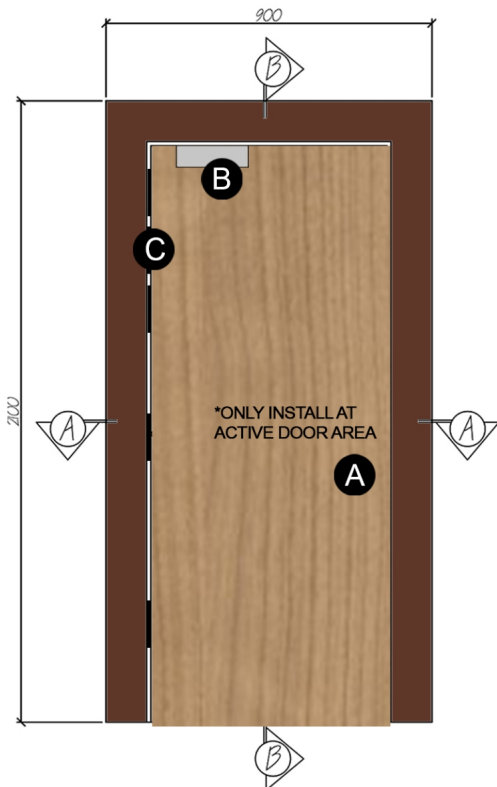

LEGEND

- A** HANDLE & MORTISE LOCK SET
- B** DOOR CLOSER
- C** STAINLESS STEEL HINGERS

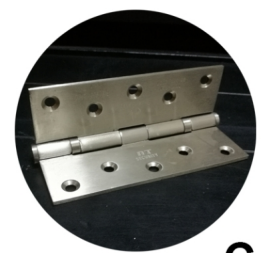
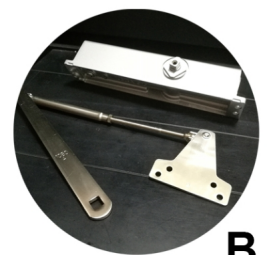

B

C

A

SAMPLE PHOTO



SAMPLE PHOTO

